

Data Sheet

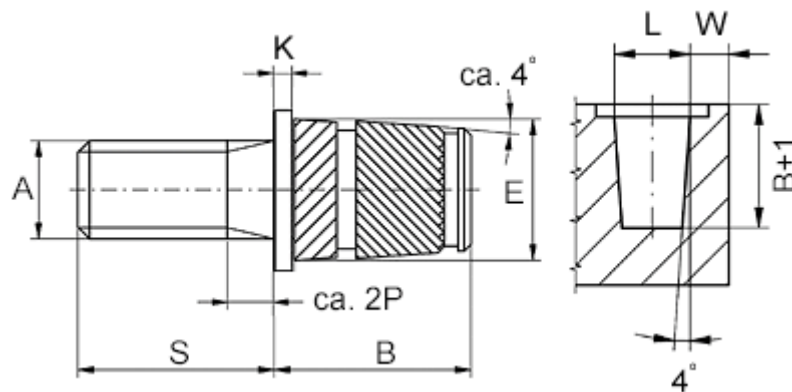

Article number: 12859100030820
Description: KLEE-coil 859 100 030.820
M3 Brass

Measures



Flange diameter E1	= 6.4
Flange height	= 0.6
Male thread A	= M3x0,5
Min distance to edge W	= 1.8
Mounting length B	= 6.1
Outer diameter E	= 4.6
Pin length S	= 6
Recommended bore diameter W +0.1	= 4.4